



## Accessory Installation Instructions

# Fender Identifier

# Fender Identifier

## Single Axle Trailers

Used on all BTU-S Series and Motorcycle Trailers, with the exception of 144" long trailers.  
Identifying features: 2 mounting holes inside fender and only amber lights.

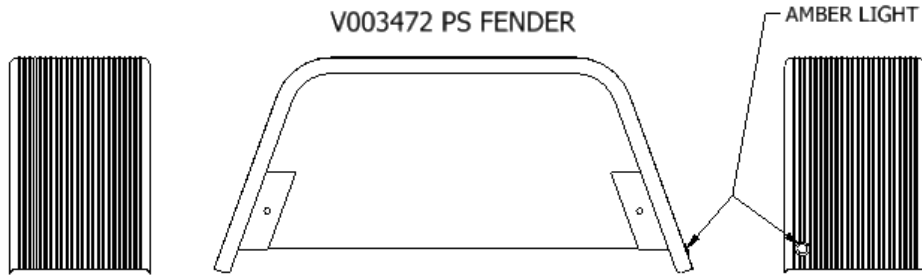
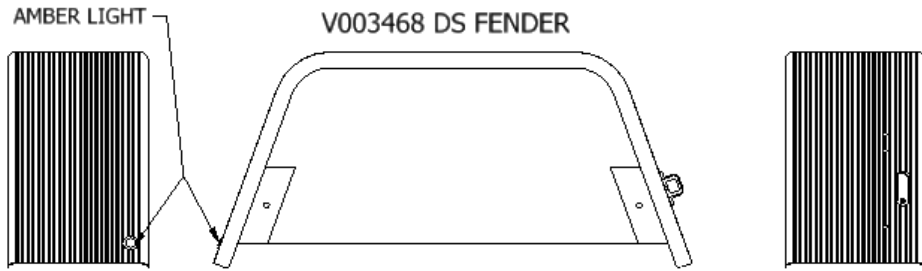

Used on 65 & 76 BTU-W Series Trailers (Wood Deck)  
Identifying features: 2 mounting holes inside fender, amber and red lights.

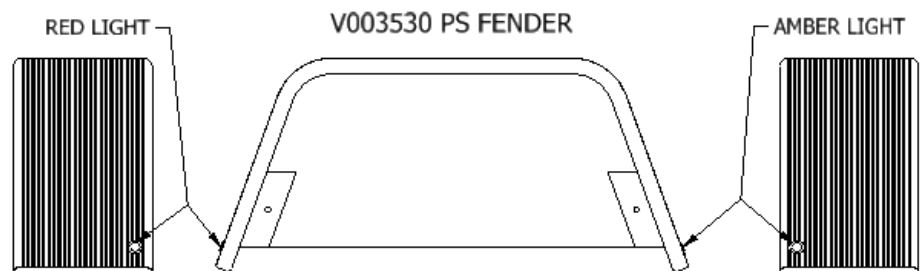
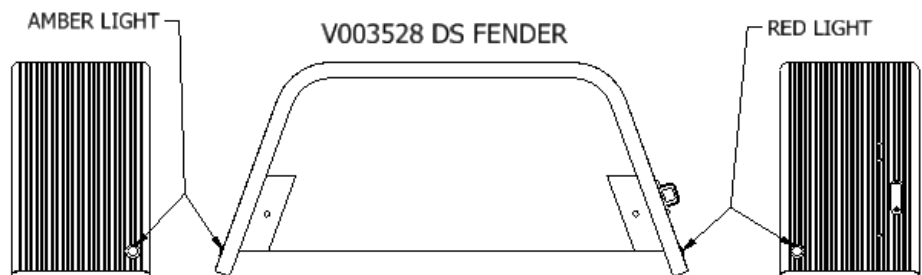

Used on BTU80168-W Series trailers (Wood Deck)  
Identifying features: 4 mounting holes inside fender, 10" fender, amber & red lights

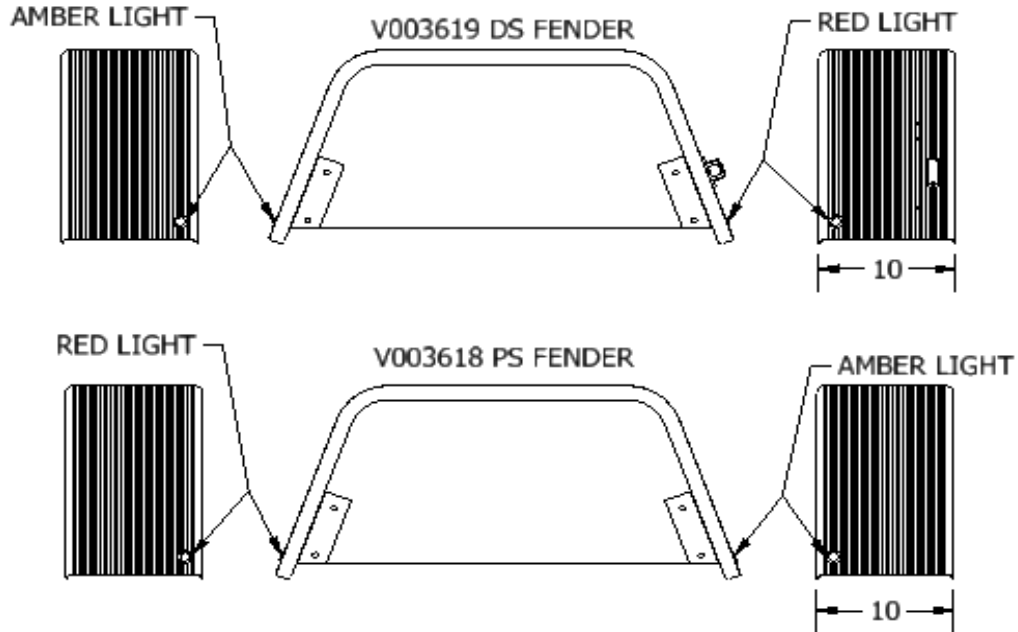

Used on all BTU79-T Series trailers (TILT UTILITY)  
Identifying features: 2 mounting holes inside fender, 10" fender, horizontal flatbar inside fender.

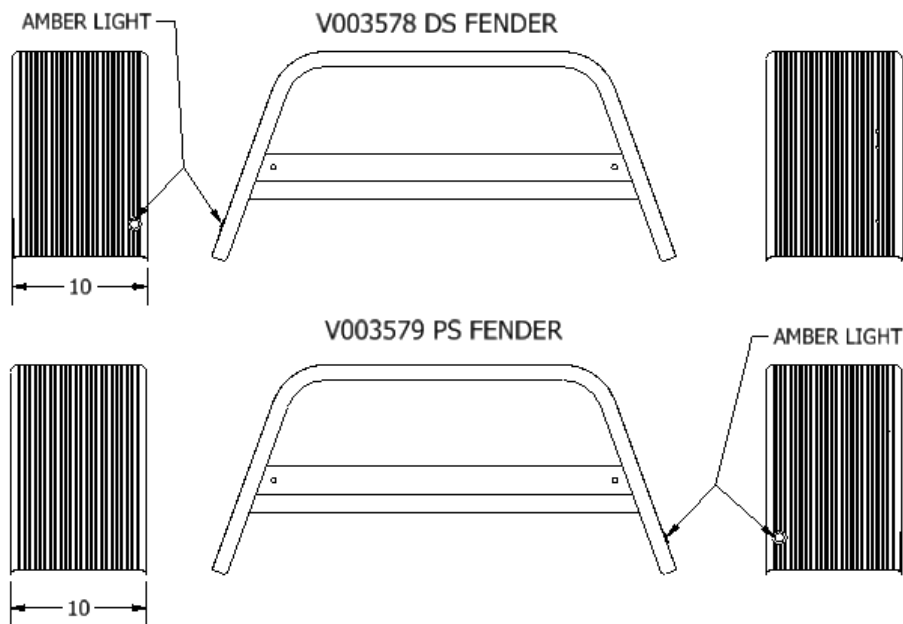

Used on all BTU81-T Series trailers (TILT UTILITY)

Identifying features: 2 mounting holes inside fender, 9" fender, horizontal flatbar inside fender.

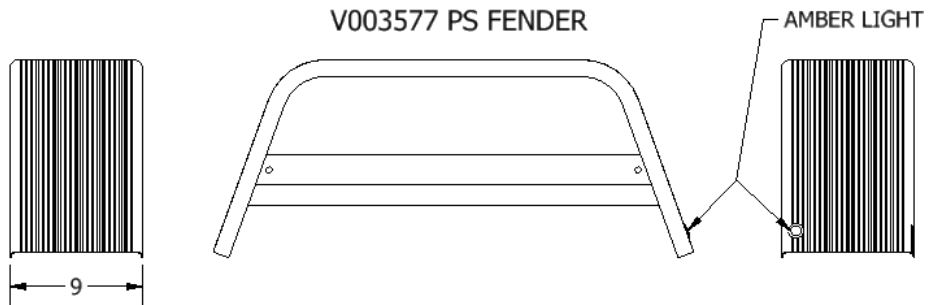
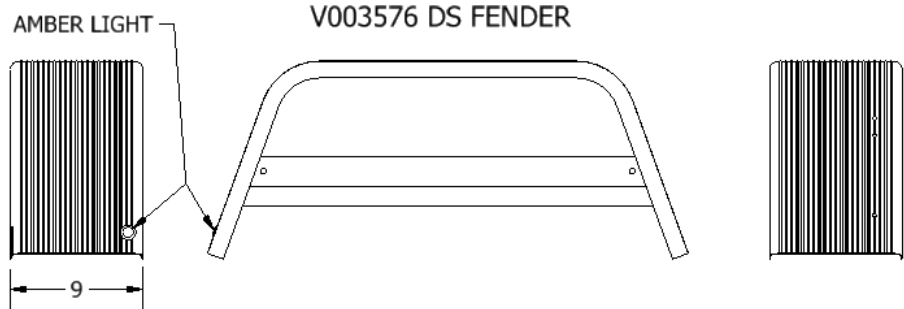

Used on all BTU-F Series trailers and 144" long S-series trailers  
Identifying features: 4 mounting holes inside fender and only amber lights.

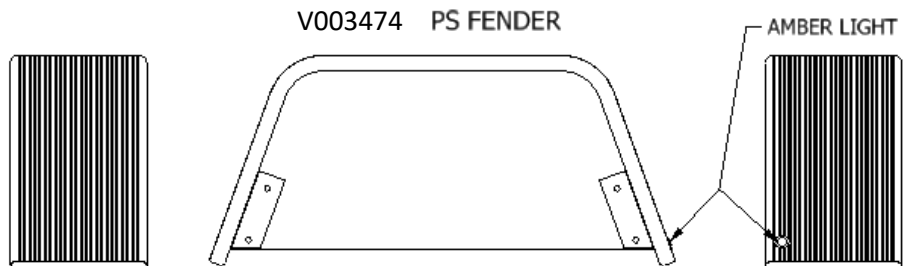
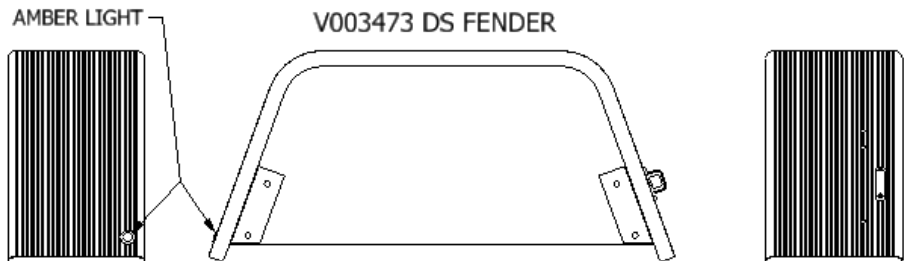

# Fender Identifier

## Tandem Axle Trailers

Used on all BTT80 Series (Tandem 80" wide trailers)

Identifying features: 4 mounting holes inside fender, 10" wide, and only amber lights.

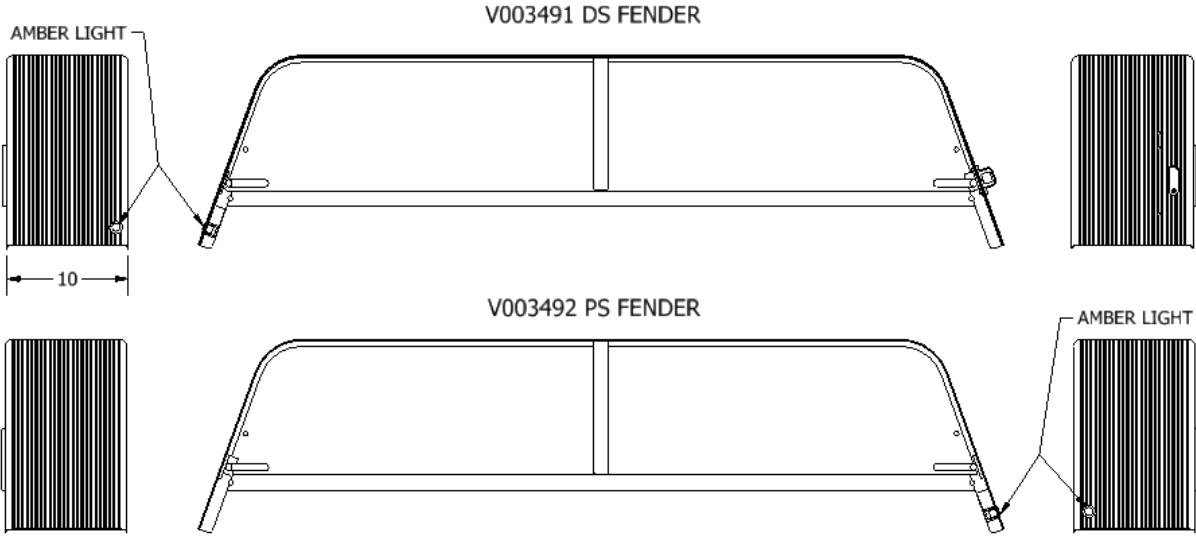

Used on BTT81xxxS Series (Tandem 81" wide truss sided trailers)  
Identifying features: 4 mounting holes on ends of fender, 9" wide, and no lights.

V002662 DS & PS FENDER

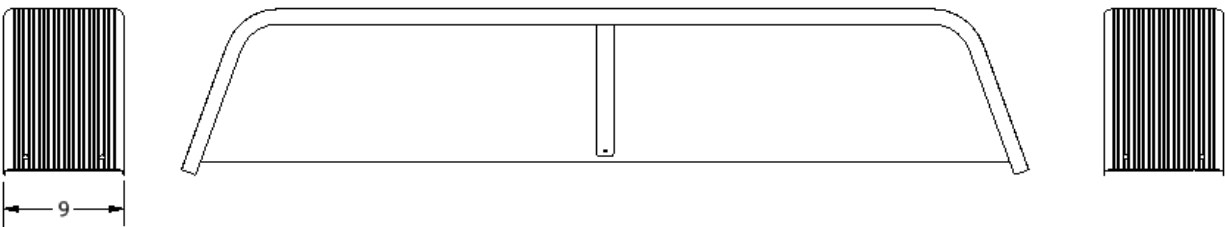

Used on all BTC81 Series (Car Haulers) and BTT81xxxSL Series  
Identifying features: 4 mounting holes on ends of fender, 10" wide, radius cuts in backer.

V001509 DS & PS FENDER

